

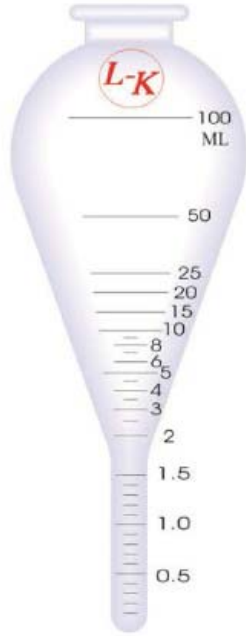

**"Finger Tubes"**  
 Finger tubes have a 12.5ml capacity. ASTM D96 or D4007

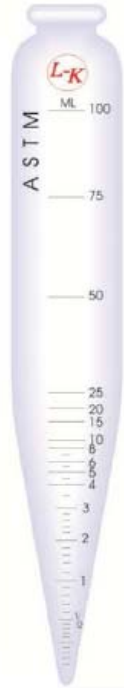

**"Pear Shaped"**  
 Pear-shaped tubes with extended tips. ASTM D96, D2273, D2709, D4007



**"Long Cone"**  
 Long Cone tubes measure 8" long. ASTM D91, D96, D893, D1796, D4007

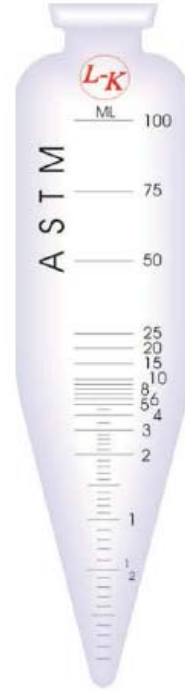

**"Short Cone"**  
 Short Cone tubes measure 6 3/8" long. ASTM D96



**"Capillary Tubes"**  
 Capillary tubes are designed for refined products such as gasoline and diesel fuel. ASTM D96 D2273 and D4007

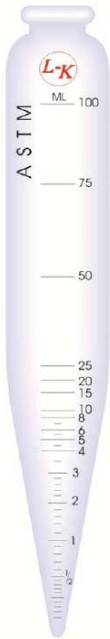

Standard Lines,  
 ML Markings,  
 Tooled Top

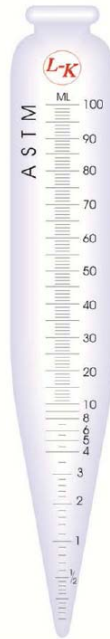

Detailed Lines,  
 ML Markings,  
 Tooled Top

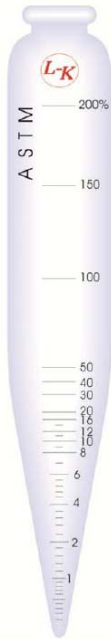

Standard Lines,  
 % Markings,  
 Tooled Top

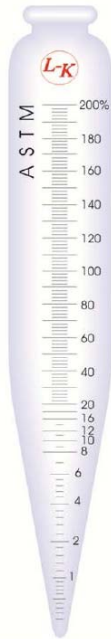

Detailed Lines,  
 % Markings,  
 Tooled Top



170 Shields Court Unit 2  
 Markham, ON L3R 9T5  
 TEL: (905) 475-5880 ext. 226  
 FAX: (905) 475-1231



← Tops offered on glassware

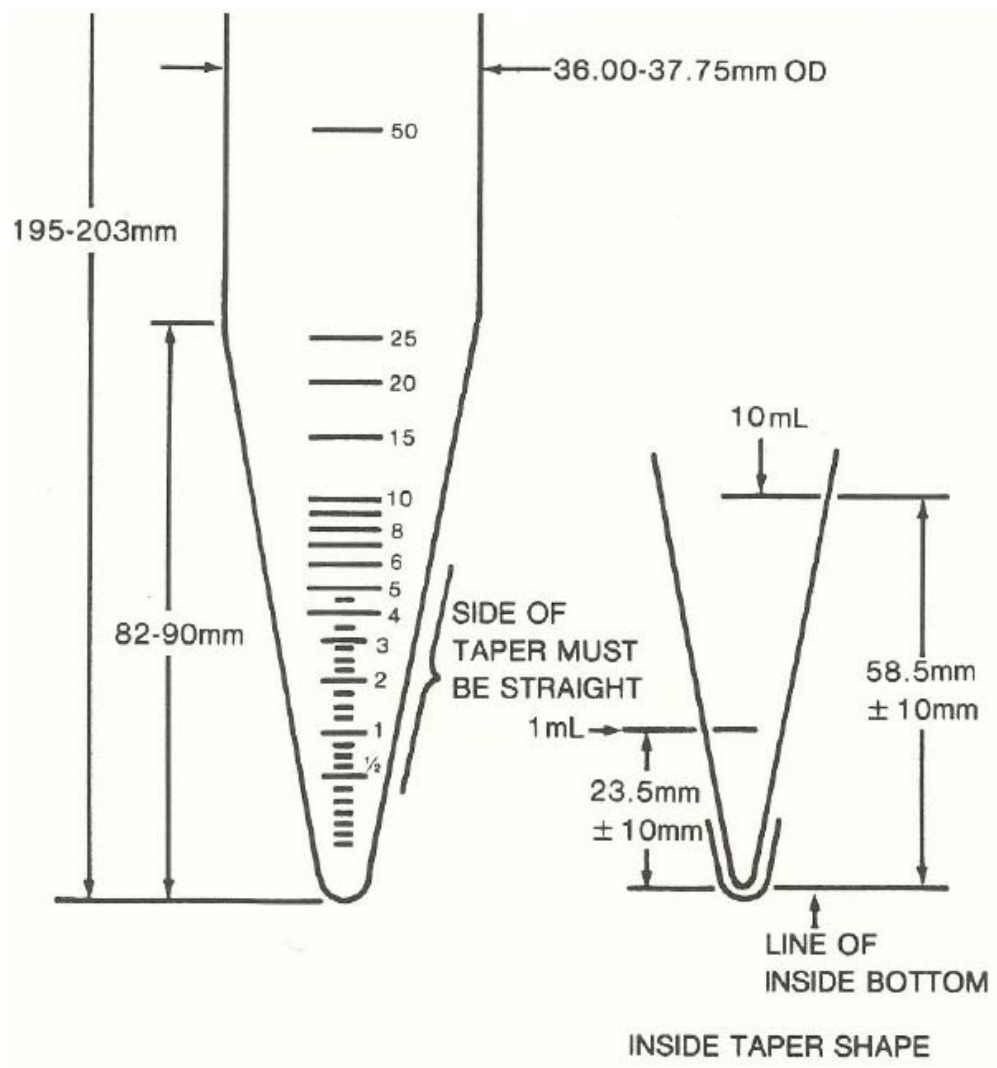

ASTM Design Specifications.