

Compact Analytical Balances

HR-AZ/HR-A

Series

HR-250AZ/HR-250A
252 g x 0.1 mg

HR-150AZ/HR-150A
152 g x 0.1 mg

HR-100AZ/HR-100A
102 g x 0.1 mg



HR-250AZ



HR-250A

Ultimate Value!



AND ...Clearly a Better Value
A&D Company, Limited
<http://www.aandd.jp>

Labequip

170 Shields Court, Unit 2
Markham, ON L3R 9T5
TEL: (905) 475-5080 ext. 226
FAX: (905) 475-1231

Finally, Globally Proven Precision at a Fair Price

What do you expect most from a precision analytical balance? If you are like us, you will agree that accuracy and reliability come before anything else. The HR-AZ/HR-A series of compact analytical balances, behind their simple design, utilize proven A&D sensor technology that delivers superior performance to all users who wish to do superior work.

Optimizing value, the HR-AZ/HR-A series realizes the following three savings:

1. Saving “Time”

Fast Stabilization in 2 Seconds

Our widely-recognized Compact Super Hybrid Sensor (C-SHS) technology¹ now enables you to perform high-speed, frustration-free weighing even at a resolution of 0.1 mg. *1 Patent pending

One-Touch Automatic Calibration (HR-AZ models only)

The built-in calibration mass lets you ensure the accuracy of your balance with just one key press.

2. Saving “Space”

Compact Footprint: 198 mm × 294 mm

With the C-SHS, the footprint of the balance is smaller than the ISO A4 (210 mm × 297 mm) paper size, maximizing opportunities for use of an analytical balance in even the smallest of spaces.

Rotary Sliding Doors

Unlike conventional analytical balances, the HR-AZ/HR-A series requires no extra space at the rear for accessing the weighing chamber, as the doors simply rotate behind the balance.

Removable Breeze Break

The breeze break is easily removed using a unique clip system, allowing fast, simple cleaning and use in confined spaces like gloveboxes and controlled environment cabinets.



Rotary Sliding Doors

3. Saving “Cost”

Lean Design for Affordability

The HR-AZ/HR-A design is all about “keeping it simple” without compromising quality or performance. Key features demanded by today’s market have been included, resulting in a compact, precise, and reliable analytical balance for the value-conscious user.



Labequip

170 Shields Court Unit 2
Markham, ON L3R 9T5
TEL: (905) 475-5880 ext. 226
FAX: (905) 475-1231

Superb Usability

Large Removable Breeze Break with Antistatic Coating

The breeze break is treated with an antistatic agent to ensure stable weighing. It also offers a large working space and can be detached for better portability and easy cleaning of the balance.



Removable Breeze Break

Clear, Reverse Backlit LCD

The contrast of the black and white display provides excellent readability even in a dimly-lit area.

Front-Mounted Spirit Level

The spirit level is easily visible when adjusting the leveling feet of the balance for accurate weighing.

Great Flexibility and Compliance

Fourteen Weighing Units

You can easily choose from g, mg, oz, oz-t, ct, momme, dwt, grain, tael, tola, pcs (counting mode), % (percent mode), DS (density mode), in addition to a user-programmable unit for conversion applications like GSM calculations in paper and fabric industries.

GLP/GMP/GCP/ISO Compliant Output

For compliance and documentation requirements, the HR-AZ/HR-A series can output the balance manufacturer, model, serial number, ID number, date and time;ⁱⁱ space for signature, and calibration records.

* ii For HR-AZ models only. Please use the AD-8121B compact printer, which has a calendar function, to print the date and time with HR-A models.

Adjustable Response Characteristics and Hold Function

From three preset combinations of weighing speed and stability (FAST, MID, or SLOW), select the one that best suits your environmental conditions (drafts and vibrations). A hold function is also available for weighing animals.

Statistical Calculation Function

The balance displays and outputs statistical calculation data including number of data, sum, maximum, minimum, range (maximum–minimum), average, standard deviation, and coefficient of variation.

Options and Accessories

Quick USB Interface (HRA-02)

The easy-to-use USB interface requires no driver or software installation for transfer of weighing data to a PC.ⁱⁱⁱ

* iii Data transfer from the balance to a PC only. Please use the RS-232C (standard interface) to serial-USB converter (AX-USB-9P, optional) for two-way communication or sending GLP or statistical calculation information via USB. Portable memory devices such as weighing environment logger (AD-1687) and data logger (AD-1688) are also available.

LAN-Ethernet Interface with WinCT-Plus Software (HRA-08)

You can send commands for controlling and acquiring data from multiple balances.



Rechargeable Battery Unit (HRA-09)

The Ni-MH rechargeable battery pack can be fitted into the balance for use without AC power (10 hours of charging for 8 hours of operation).

Density Determination Kit (AD-1654)

Using this kit, it is easy to calculate the density of a solid or liquid substance in density mode.

Specifications

Models	HR-250AZ	HR-150AZ	HR-100AZ	HR-250A	HR-150A	HR-100A
Weighing capacity	252 g	152 g	102 g	252 g	152 g	102 g
Minimum weighing value	0.1 mg					
Repeatability (standard deviation)	0 to 200 g: 0.1 mg	0.1 mg		0 to 200 g: 0.1 mg	0.1 mg	
	200 to 252 g: 0.2 mg			200 to 252 g: 0.2 mg		
Linearity	±0.3 mg	±0.2 mg		±0.3 mg	±0.2 mg	
Stabilization time (when set to FAST under a good environment)	Approx. 2 seconds ^{iv}					
Sensitivity drift	±2 ppm/°C (10 to 30 °C/50 to 86 °F)					
Internal calibration	Yes			No		
Clock and calendar function	Yes			No		
Operating environment	5 to 40 °C (41 to 104 °F), 85% RH or less (no condensation)					
Display refresh rate	5 times/second (10 times/second can be selected)					
Display mode	g, mg, oz, oz-t, ct, momme, dwt, grain, tael, tola, pcs (counting mode), % (percent mode), DS (density mode)					
Counting mode	Minimum unit mass	0.1 mg				
	Number of samples	10, 25, 50 or 100 pieces				
Percent mode	Minimum 100% reference mass	10.0 mg				
	Minimum 100% display	0.01%, 0.1%, or 1% (depends on the reference mass stored)				
Interface	RS-232C					
Applicable calibration weight value	250 g, 200 g 100 g, 50 g	150 g, 100 g, 50 g	100 g, 50 g	250 g, 200 g 100 g, 50 g	150 g, 100 g, 50 g	100 g, 50 g
Weighing pan size	Ø90 mm					
External dimensions	198 (W) × 294 (D) × 315 (H) mm					
Net weight	Approx. 3.9 kg			Approx. 3.5 kg		
Power supply	AC adapter					
Power consumption	Approx. 11 VA (supplied to the AC adapter)					

* iv The factory setting is MID, whose stabilization time is approx. 3 seconds.

Options

- HRA-02* Quick USB interface with cable
 - HRA-08* Ethernet interface with WinCT-Plus software
 - HRA-09* Built-in rechargeable battery
- * The HRA-02, HRA-08 and HRA-09 cannot be used at the same time

Dimensions (mm/inches)

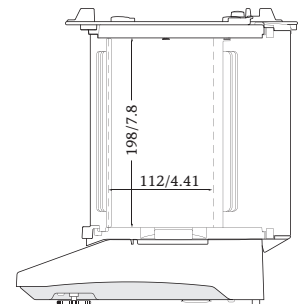
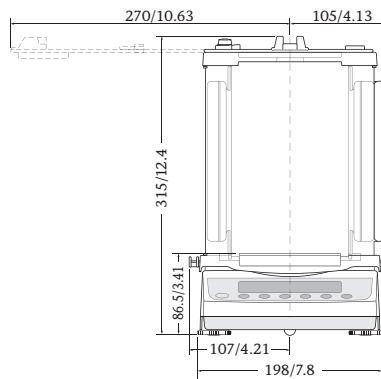
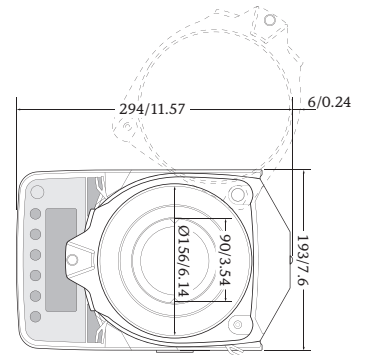

Accessories

- AD-1654 Density determination kit
- AD-1683 Static eliminator
- AD-1684 Electrostatic field meter
- AD-1687 Weighing environment logger
- AD-1688 Weighing data logger
- AD-1689 Tweezers for calibration weight
- AD-8121B Compact printer
- AD-8526 Serial/Ethernet converter
- AD-8527 Quick USB adapter
- AD-8920A Remote display
- AD-8922A Remote controller
- AX-HRA-31 Main unit cover (5 pcs)
- AX-USB-9P Serial/USB converter



AD-1683



AD-1687